

QUESTO DISEGNO NON PUO' ESSERE
RIPRODOTTO NE MOSTRATO A TERZE
PERSONE ART. 115-33 C. C.-293 C. P.

1

2

3

4

A

B

C

D

E

F

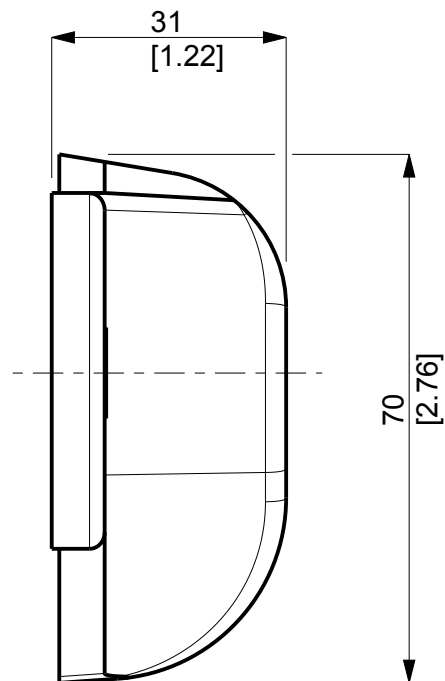
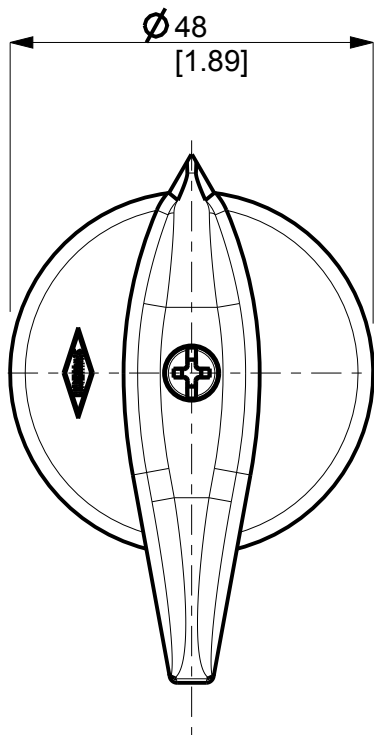

Quote :mm[in]

EDIZ.		MODIFICA				DATA	SIGLA
MATERIALE: --		FINITURA: --					
 ERSCE		Dis.Mangiapane	Impiego	Scala	Toll.Gen.	Sost.il	
		Contr.	--	1:1	Lineare	Sostituito dal	
		Data: 09-Mar-15			Angoli	Direttorio	
OGGETTO:MANOPOLA M6					DISEGNO VAG-M6-3D		EDIZ. 1